



1200V Dual Silicon Carbide Power Module

GE12047BCA3

V_{DS} : 1200 V I_{DS} : 475 A

Superior performance for high power, high frequency applications needing best-in-class power density



Features

- Highly reliable GE SiC MOSFET devices
- Low $R_{DS(ON)}$ (3.1 m Ω) (device only)
- Low stray inductance (1 nH)
- SiC die qualified to +200°C
- Ultra-low switching losses over entire operating range
- Body diode with minimal reverse recovery
- Integrated temperature sensing
- AlSiC Baseplate and Si₃N₄ AMB Substrate

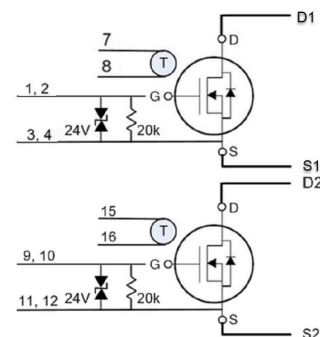

MOSFET DC Characteristics @ $T_j = 25^\circ\text{C}$ (unless otherwise specified)

Symbols	Parameters	Min.	Typ.	Max.	Unit	Test Conditions	Notes
I_{DS}	Continuous Drain Current			475	A	$V_{GS} = 20\text{ V}, T_c = 25^\circ\text{C}$	Per Switch
				333		$V_{GS} = 20\text{ V}, T_c = 100^\circ\text{C}$	
				272		$V_{GS} = 20\text{ V}, T_c = 125^\circ\text{C}$	
$I_{DS,pulse}$	Pulsed Drain Current			950	A	$T_c = 25^\circ\text{C}, t_p = 1\text{ ms}$	
V_{DSmax}	Drain - Source Breakdown Voltage	1200			V	$V_{GS} = 0\text{ V}, I_{DS} = 100\ \mu\text{A}$	
V_{GSmax}	Maximum Gate - Source Voltage			-15/+23	V	$V_{DS} = 0\text{ V}$	
V_{GSop}	Recommended Gate - Source Voltage			-5/+20	V		
T_{Jmax}	Junction Temperature			175	$^\circ\text{C}$		
T_c	Case Temperature Range	-55		150	$^\circ\text{C}$		
T_{STG}	Storage Temperature Range	-55		150	$^\circ\text{C}$		
P_D	Power Dissipation			1250	W	$T_c = 25^\circ\text{C}$	



(Continued) **MOSFET DC Characteristics @ $T_J = 25^\circ\text{C}$** (unless otherwise specified)

Symbols	Parameters	Min.	Typ.	Max.	Unit	Test Conditions	Notes
I_{DS}	Continuous Drain Current			475	A	$V_{GS} = 20\text{ V}, T_c = 25^\circ\text{C}$	Per Switch
$V_{GS(th)}$	Gate Threshold Voltage	2.5	2.8	4.5	V	$V_{GS} = V_{DS}, I_{DS} = 160\text{ mA}$	
I_{DSS}	Drain Leakage Current			0.10	mA	$V_{DS} = 1200\text{ V}, V_{GS} = 0\text{ V}, T_J = 25^\circ\text{C}$ $T_J = 200^\circ\text{C}$	
				1.6			
I_{GSS}	Gate-Source Leakage Current			160	nA	$V_{GS} = -15/+23\text{ V}$	
$R_{DS(on)}$	On State Resistance (Device Only)		3.1	4.4	m Ω	$V_{GS} = 20\text{ V}, I_{DS} = 475\text{ A}, T_J = 25^\circ\text{C}$ $T_J = 175^\circ\text{C}$	Per Switch
			5.6	6.8			
$R_{G(int)}$	Gate-Source series resistance		0.90		Ω	$V_{GS} = 0\text{ V}, f = 100\text{ kHz}, T_c = 25^\circ\text{C}$	

MOSFET Dynamic Characteristics per switch @ $T_J = 25^\circ\text{C}$ (unless otherwise specified)

Symbols	Parameters	Min.	Typ.	Max.	Unit	Test Conditions	Notes
C_{iss}	Input Capacitance		29.3		nF	$V_{GS} = 0\text{ V}$ $V_{DS} = 600\text{ V}$ $f = 100\text{ kHz}$	
C_{oss}	Output Capacitance		1.60		nF		
C_{rss}	Reverse Transfer Capacitance		0.13		nF		
E_{on}	Turn-On Switching Energy		7.72		mJ	$V_{GS} = 0\text{ V to } +20\text{ V}$ $V_{DS} = 800\text{ V}$ $I_{DS} = 350\text{ A}$ $R_{G(ext)} = 0\ \Omega$	Tested in half-bridge configuration
E_{off}	Turn-Off Switching Energy		3.79		mJ		
t_r	Rise Time		21.9		ns		
t_f	Fall Time		38.9		ns		
Q_G	Total Gate Charge		1248		nC	$V_{GS} = 0\text{ to } 18\text{ V}$ $V_{DS} = 900\text{ V}$ $I_{DS} = 240\text{ A}$	
Q_{GD}	Gate-Drain Charge		536		nC		
Q_{GS}	Gate-Source Charge		176		nC		

Body Diode Characteristics per switch @ $T_J = 25^\circ\text{C}$ (unless otherwise specified)

Symbols	Parameters	Min.	Typ.	Max.	Unit	Test Conditions	Notes
I_{SD}	Pulsed body diode current			720	A	$V_{GS} = 0\text{ V}$	1.
V_{SD}	Diode Forward Voltage		4.69		V	$V_{GS} = 0\text{ V}, I_{SD} = 475\text{ A}, T_J = 25^\circ\text{C}$	

1. Use of body diode is recommended in pulse mode only, with pulse duration up to 1 μs

Thermal Characteristics

Symbols	Parameters	Min.	Typ.	Max.	Unit	Test Conditions	Notes
R_{th}	Thermal Resistance Junction-to-Case		0.10	0.12	$^\circ\text{C/W}$	JESD51-14	Per Switch



Temperature Sensor Characteristics

Symbols	Parameters	Min.	Typ.	Max.	Unit	Test Conditions	Notes
R_{RTD}	Rated Resistance of RTD		1k		ohm		2.
	Tolerance of Resistance		0.12		%		
	Accuracy		0.3		°C		
	Measuring Current	100		300	μA		
TCR	Temperature Coefficient		3850		ppm/K		
	Operating Temperature	-70		+500	°C		
	Insulation Resistance	100			Mohm	20°C	

2. RTD is mounted directly over center-most die allowing direct reading of T_j

Module packaging data

Symbols	Parameters	Min.	Typ.	Max.	Unit	Test Conditions	Notes
V_{Iso}	Case Isolation Voltage	4			kV	AC 50 Hz, 1 min, 25°C	
CTI	Comparative Tracking Index		600				
M_s	Mounting Torque			5.0 4.0	N-m	Power Terminals Baseplate	
L_{D1S1}	Loop Inductance		1		nH		
L_{D2S2}	Loop Inductance		1		nH		
	Module Mass		0.12		kg		
	Clearance Distance		9		mm	D1 to D2	
			4		mm	D1 to S1	
			23		mm	Pins 1, 2 to S1	
			25		mm	Pins 9, 10 to S1	
			9		mm	D1, S2 to Baseplate	
			12		mm	Pins 7, 8 to Baseplate	
	Creepage Distance		11		mm	D1 to D2	
			6		mm	D1 to S1	
			28		mm	Pins 1, 2 to S1	
			30		mm	Pins 9, 10 to S1	
			12		mm	D1, S2 to Baseplate	
			17		mm	Pins 7, 8 to Baseplate	
M_{BP}	Base Plate Material		AlSiC				



Typical performance: **GE12047BCA3**

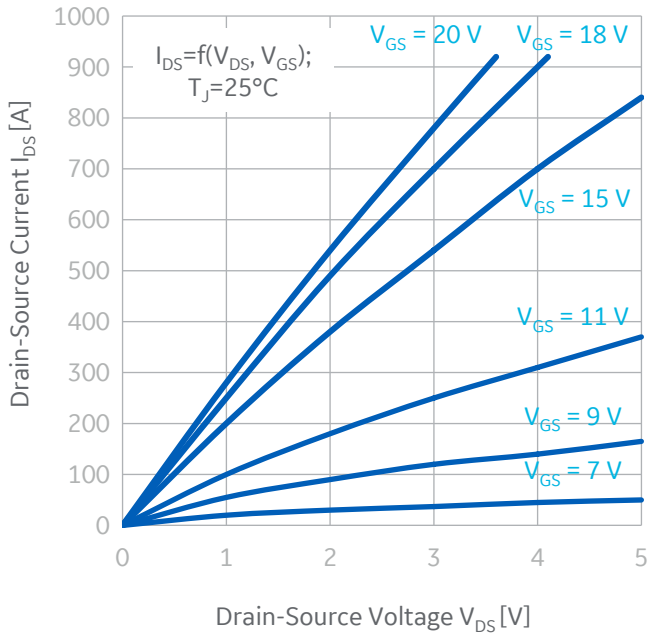

Figure 1: Output Characteristics (25 °C)

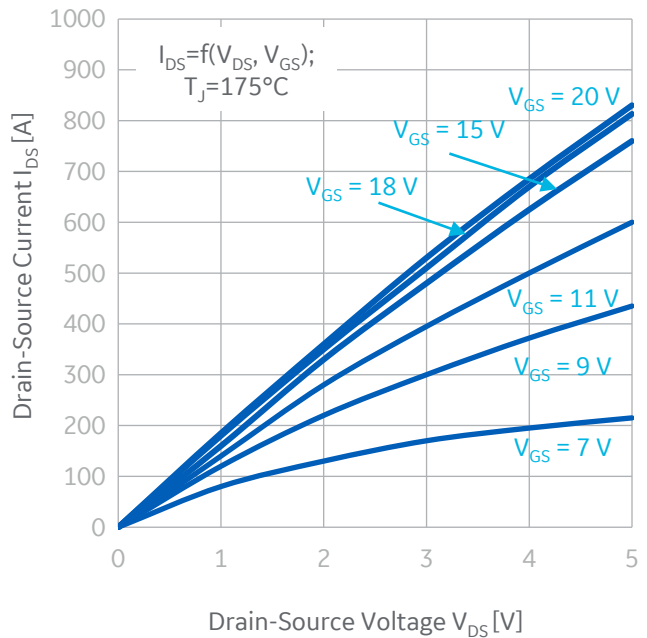

Figure 2: Output Characteristics (175 °C)

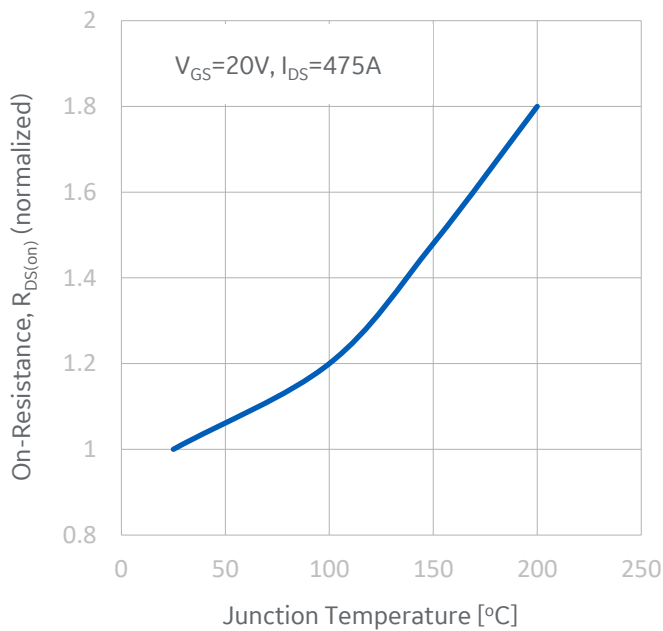

Figure 3: Normalized On-state Resistance vs. Temperature

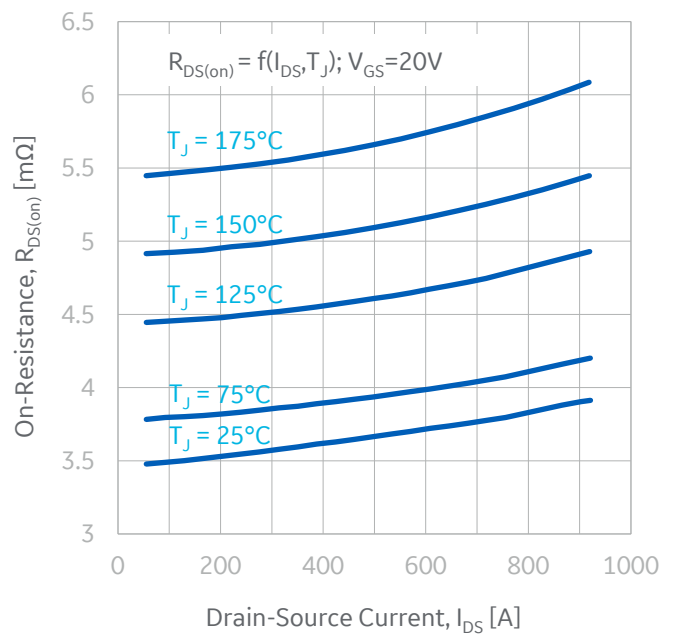

Figure 4: Module Drain-Source On-state Resistance



Typical performance: **GE12047BCA3**

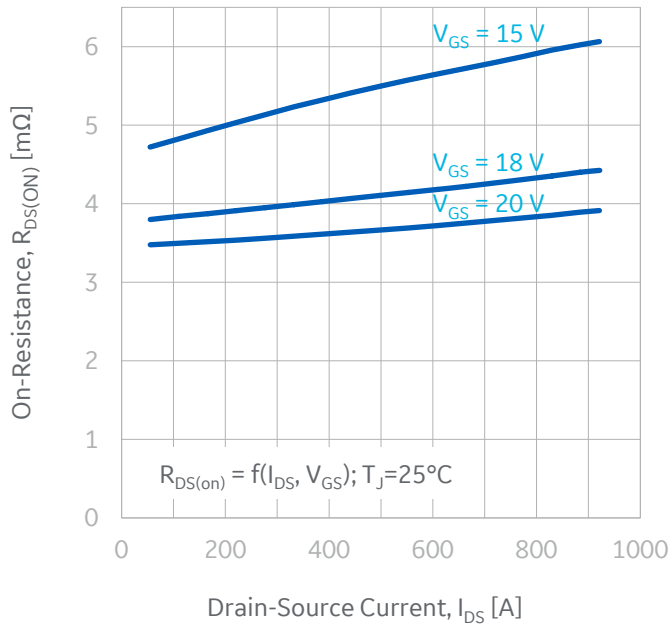

Figure 5: Module Drain-Source On-state Resistance

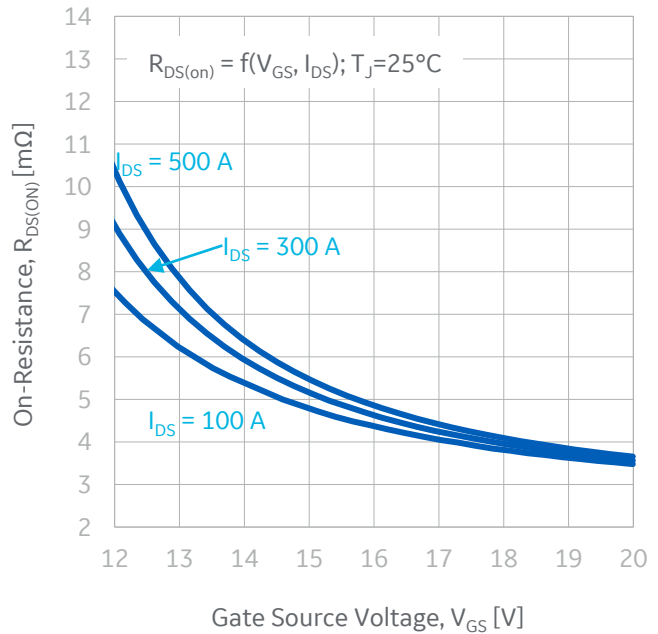

Figure 6: Drain-Source On-state Resistance vs. Gate Voltage

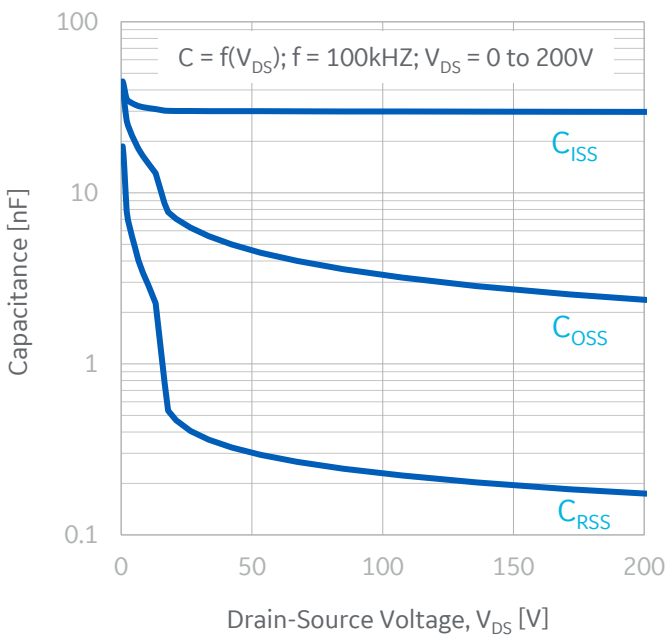

Figure 7: Input Capacitance to 200 V

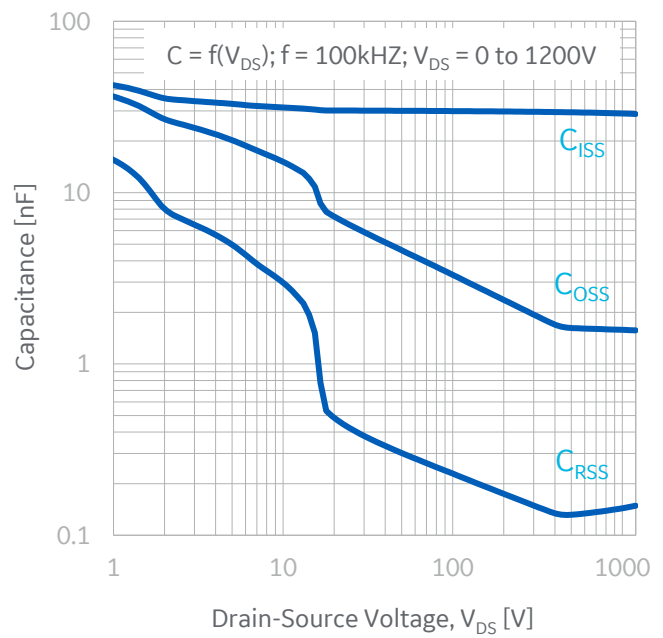

Figure 8: Input Capacitance to 1200 V



Typical performance: **GE12047BCA3**

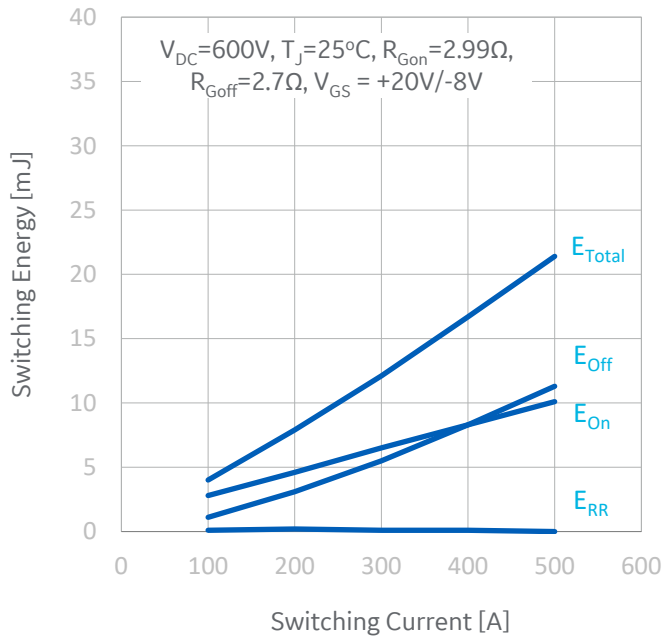

Figure 9: Switching Energy vs. Drain Current (600 V)

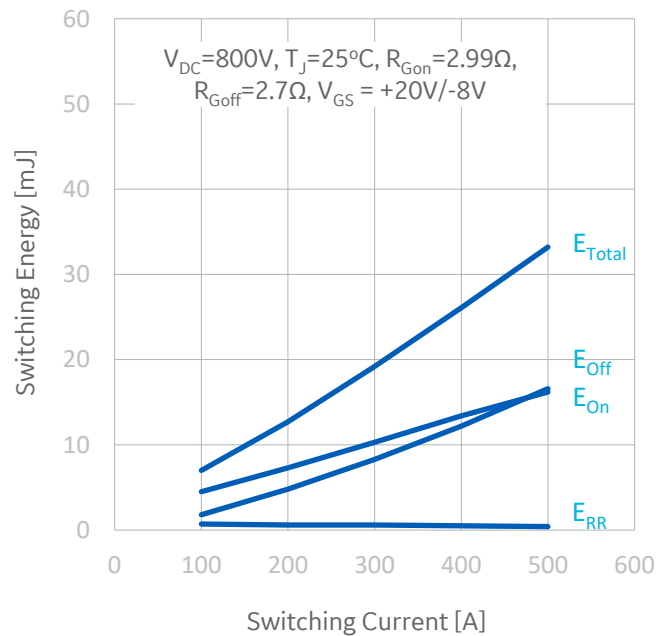

Figure 10: Switching Energy vs. Drain Current (800 V)

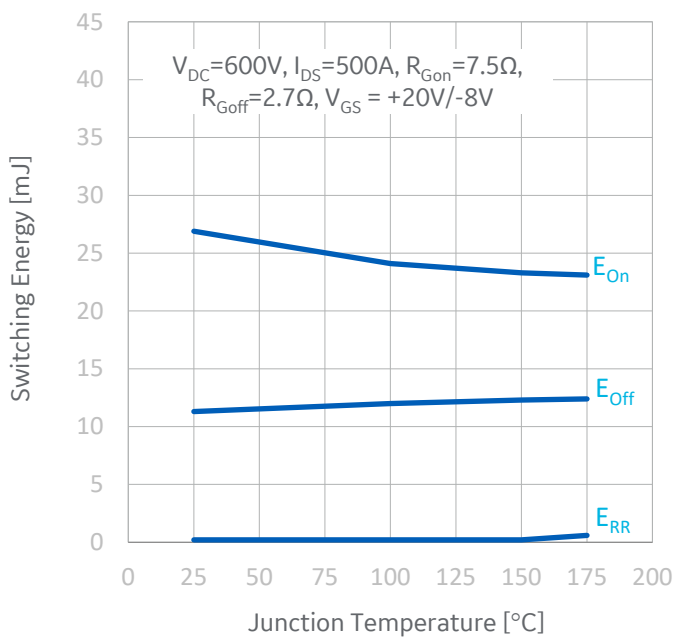

Figure 11: Switching Energy vs. Junction Temperature

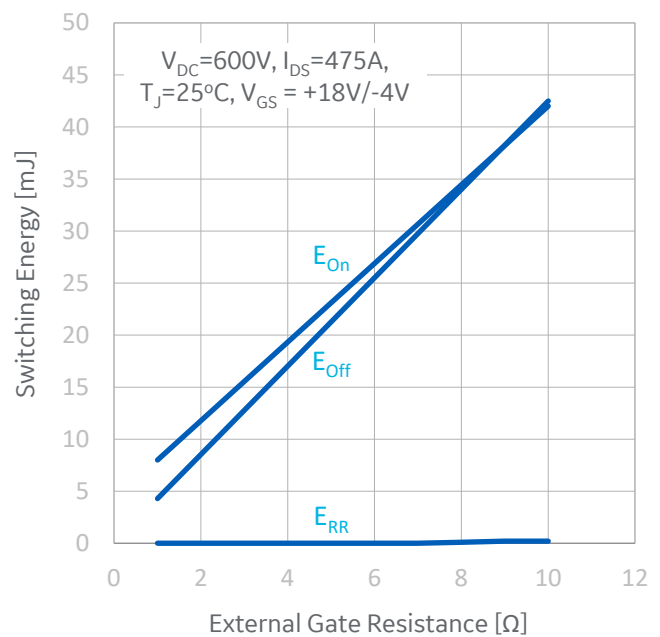

Figure 12: Switching Energy vs. Gate Resistance



Typical performance: **GE12047BCA3**

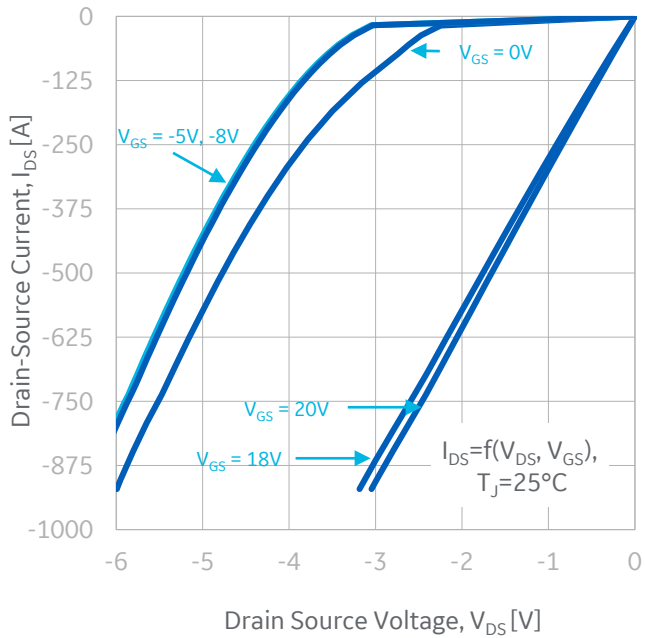

Figure 13: 3rd Quadrant Characteristics (25°C)

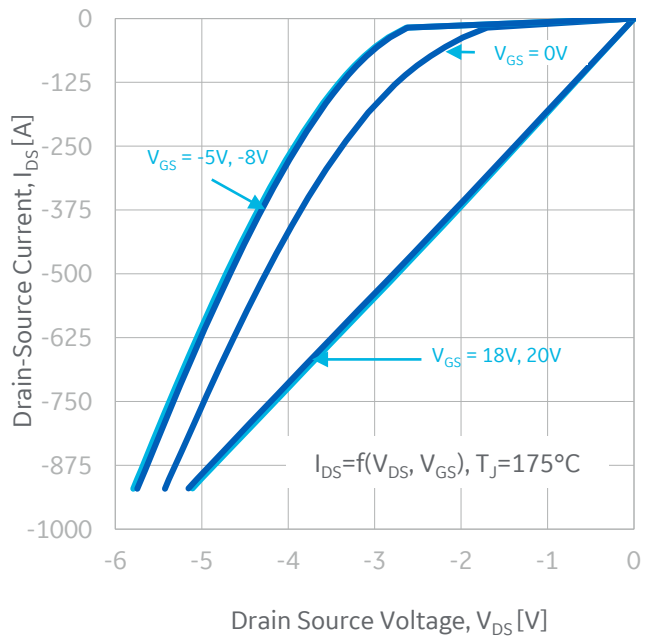

Figure 14: 3rd Quadrant Characteristics (175°C)

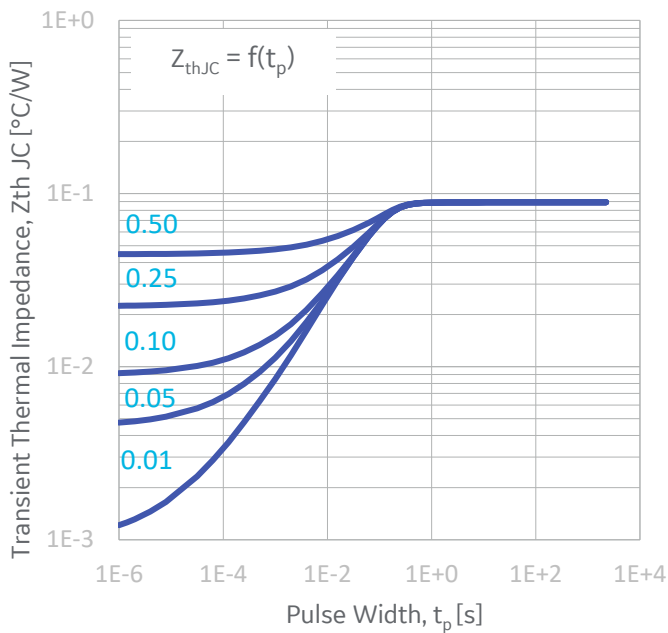

Figure 15: Transient Thermal Impedance

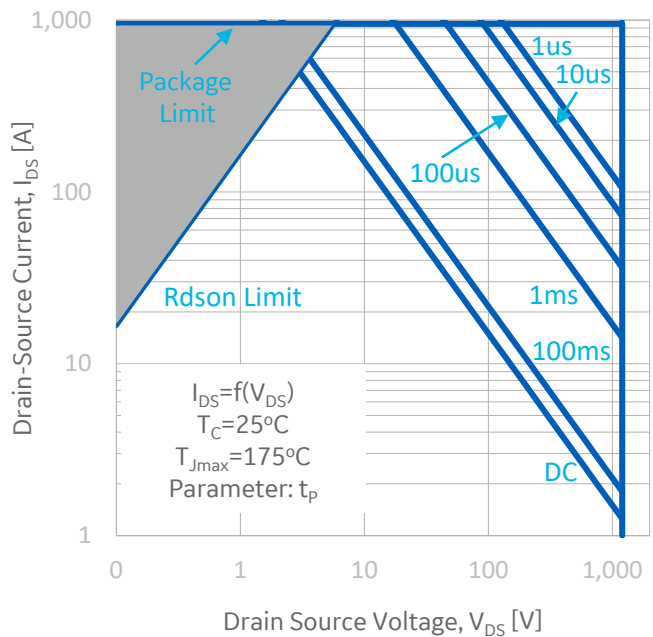

Figure 16: Forward-Bias Safe Operating Area



Typical performance: **GE12047BCA3**

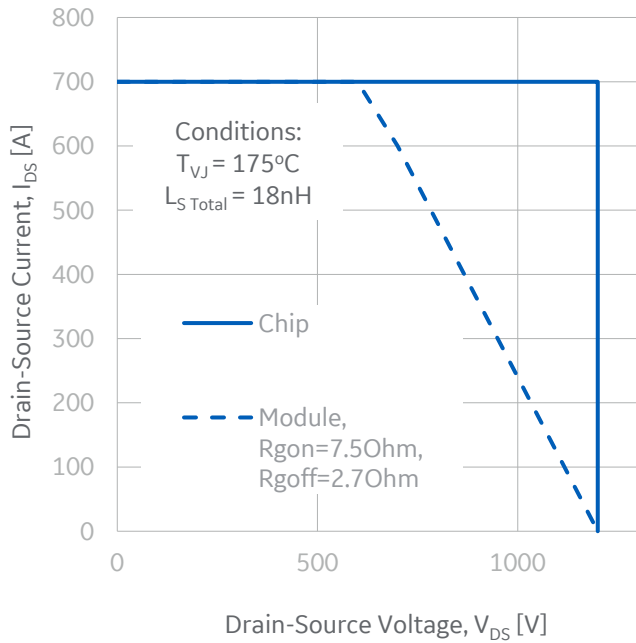

Figure 17: Reverse-Bias Safe Operating Area

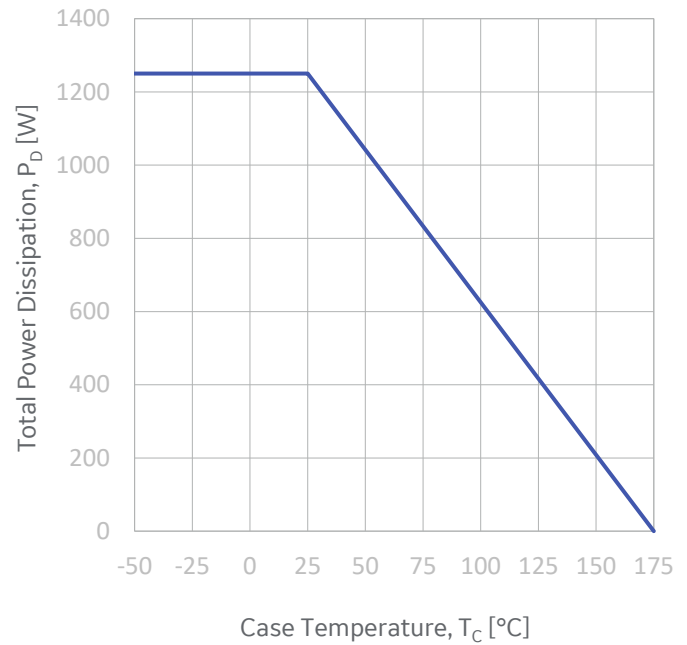
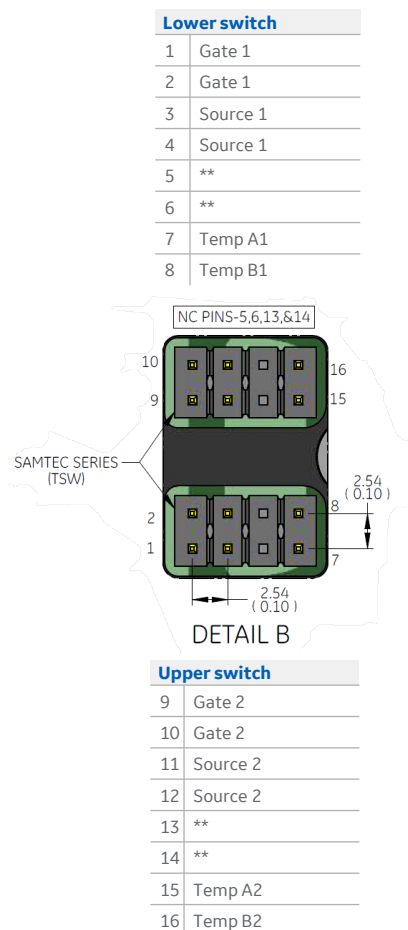

Figure 18: Maximum Power Dissipation vs. Case Temperature



Electrical interface outline drawing



Module dimensions (millimeters)

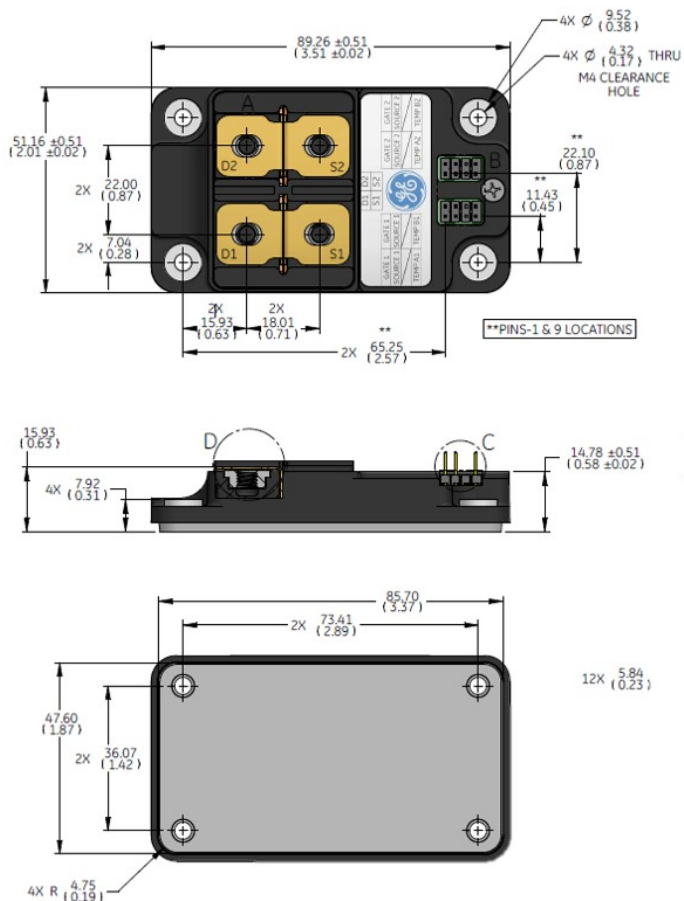

Disclaimer

The data presented in this document are for informational purposes only and shall in no event be regarded as a guarantee of conditions or characteristics. Any warranty or license for this product shall be specified and governed by the terms of a separate purchase agreement. General Electric Company does not assume any liability arising out of the application or use of this product; neither does it convey any license under its patent rights, nor the rights of others.

General Electric Company reserves the right to make changes in specifications and features shown herein to improve reliability, function, or design, or discontinue this product, at any time without notice or obligation. Contact your GE representative for the most current information.

Warning

This product is not authorized for use (1) in life support systems or (2) for applications implanted into the human body, without the express written approval of General Electric Company.

Questions or need help designing in GE SiC Power modules? Please contact:

SiC.Products@ge.com

GE Aviation
2705 Gateway Dr.
Pompano Beach, FL 33069
(954) 977-2046

Document revisions

Rev 1.1 - Public Release - December 9, 2021